

FALC**mod. LINCE**
mod. LINCE AVANT**TRINCIATRICI - BROYEURS - SHREDDERS**
HÄCKSLER - TRITURADORAS

Trinciatrici speciali particolarmente robuste, indicate per lavorazioni specializzate come ad esempio in piantagioni di ananas e banana. Per trattori da 120 a 160 HP



Broyeurs speciaux particulièrement robustes, adaptés aux travaux spécialisés comme, par exemple, dans les plantations d'ananas et de bananes. Pour tracteurs de 120 à 160 CV



Special and particularly strong shredders, suitable to specialized applications such as pineapple and banana plantations. For 120-160 HP tractors





Besonders robuste Häcksler für Sonderbearbeitungen, wie z.B. in Ananas- und Bananenplantagen. Für Traktoren von 120 bis 160 PS





Trituradoras especiales muy robustas para trabajos especializados, como por ejemplo en plantaciones de piña y plátano. Para tractores de 120 a 160 CV

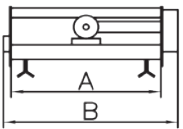

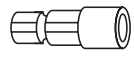

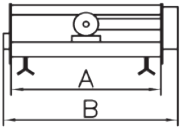
LINCE									
	Kg.	LBS	A mm.	B mm.	A inches	B inches	N.	HP	PTO
2300	1680	3704	2305	2719	90,75	107,05	48	120-160	1000

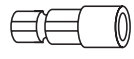
LINCE AVANT									
	Kg.	LBS	A mm.	B mm.	A inches	B inches	N.	HP	PTO
2300	1655	3649	2305	2719	90,75	107,05	48	120-160	1000



LINCE



LINCE



Trinciatrice speciale costruita con componenti sovradimensionati per i lavori agricoli più gravosi. Adatto per trinciatura e pulizia in zone boschive. Il rotore è con doppia trasmissione. Il tiraggio delle cinghie è automatico. Bocca anteriore alta per favorire l'ingresso del materiale da trinciare



Broyeur special de conception très robuste indiqué pour les travaux de broyage les plus difficiles, et aussi pour l'entretien des zones boisées. Le rotor est entraîné avec une double transmission. Les tendeurs de courroies sont automatiques. "Bouche" frontale haute pour faciliter l'entrée du produit à broyer.



Special shredder, manufactured with oversized components, suitable to heavy-duty chopping and cleaning in wooded areas. The rotor is driven from both sides by belt drive transmissions with automatic belt tensioners. High front "mouth" to facilitate the entry of the residues to be chopped.



Sonderhäcksler, mit überdimensionierten Bestandteilen hergestellt. Geeignet zu landwirtschaftlichen Schwerarbeiten, zum Mulchen und zur Wartung in Waldflächen. Der Rotor wird mit einem Doppelriemen angetrieben. Die Riemenspannung ist automatisch. Hohe vordere Öffnung, den Eintritt des Materials zu erleichtern.



Trituradora especial construida con componentes sobredimensionados destinada a trabajos duros y apta también para el mantenimiento de zonas boscosas. El rotor es de doble transmisión. El tensor de correas es automático. Boca anterior alta para facilitar la entrada del material a cortar.



3



5

LINCE AVANT



LINCE

4



6

LINCE AVANT

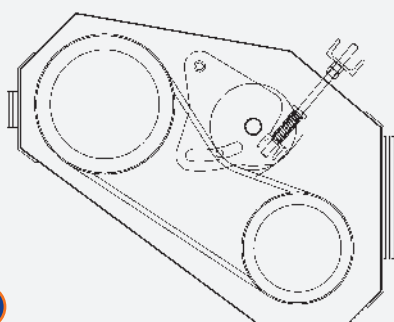

7

54mm



8



- Doppia trasmissione
- Tendicinghie automatico (foto 7)
- Coltelli speciali tipo 1 (foto 8)
- Controcoltello a pettine e secondo controcoltello
- Lamiera d'usura
- **LINCE** (foto 3-4): con attacco posteriore, con 2 ruote fisse regolabili in altezza e scatola con ruota libera interna.
- **LINCE AVANT** (foto 5-6): abbinabile anteriormente e posteriormente al trattore, con rullo, con 2 convogliatori laterali e ruota libera sul cardano.



- Double transmission
- Tendeur automatique des courroies (photo 7)
- Couteaux spéciaux type 1 (photo 8)
- Contre coutau cranté et 2ème contre couteau
- Tôle d'usure
- **LINCE** (photo 3-4): avec attelage arrière, avec 2 roues fixes réglables en hauteur et boîtier avec roue libre interne.
- **LINCE AVANT** (photo 5-6): peut être monté à l'avant ou à l'arrière du tracteur, avec rouleau, avec 2 guides laterales et avec roue libre sur le cardan.



- Dual drive
- Automatic belt tightener (photo 7)
- Special blades type 1 (photo 8)
- Toothed counter blade and 2nd counter blade
- Wear & tear sheet
- **LINCE** (photo 3-4): with rear hitch, with 2 fixed wheels adjustable in height and gearbox with internal free wheel.
- **LINCE AVANT** (photo 5-6): it can be fitted both in the front and back of the tractor, with roller, with 2 lateral guides and with free wheel on the cardan shaft.



- Doppelantrieb
- Automatische Spannvorrichtung (Foto 7)
- Sondermesse Typ 1 (Foto 8)
- Gezahntes Gegenmesser und zweites Gegenmesser
- Verschleißblech
- **LINCE** (Foto 3-4): mit hinterem Anschluss, mit 2 festen höhenverstellbaren Rädern und Getriebe mit innerem Freilauf
- **LINCE AVANT** (Foto 5-6): für Front- und Heckanbau am Traktor, mit Walze, mit 2 seitlichen Fördergeräten und Freilauf auf der Gelenkwelle.



- Doble transmisión
- Tensor automático de correas (foto 7)
- Cuchillas especiales tipo 1 (foto 8)
- Contracuchilla dentada y segunda contracuchilla
- Chapa de desgaste
- **LINCE** (foto 3-4): Con enganche trasero, con 2 ruedas fijas ajustable en altura o caja con rueda libre interna.
- **LINCE AVANT** (foto 5-6): acoplable anteriormente y posteriormente al tractor, con rodillo, con 2 transportadores laterales y rueda libre en el cardan.



Nel LINCE la mancanza della barra posteriore rende "libera", senza ostacoli, la fuoriuscita del materiale trinciato.

Nel LINCE AVANT la mancanza della stessa barra favorisce l'intercettazione delle piante da trinciare. Quanto sopra è particolarmente interessante nella trinciatura di piantagioni di ananas.



Dans le LINCE l'absence de la poutre arrière facilite l'éjection du produit broyé.

Dans le LINCE AVANT l'absence de la même poutre permet d'intercepter les plantes à broyeur. Ce détail est particulièrement intéressant pour le broyage d'ananas.



On the LINCE the absence of the rear bar allows the free outflow, without obstacles, of the shredded material.

On the LINCE AVANT the absence of this bar facilitates to intercept the plants to be shredded. This detail is particularly interesting in pineapple plantations.



Beim LINCE bewirkt das Fehlen der hinteren Schiene, dass das gehäckselte Material „frei“, ohne Hindernisse austritt.

Beim LINCE AVANT erleichtert das Fehlen derselben Schiene das Abfangen der zu häckselnden Pflanzen. Dieses Detail ist sehr interessant in Ananasplantagen.



En el modelo LINCE la ausencia de la barra trasera deja "libre", sin obstáculos, la salida del material cortado.

En el modelo LINCE AVANT la ausencia de la misma barra favorece la interceptación de las plantas a cortar.

Este detalle es particularmente interesante en plantaciones de piña.



LINCE AVANT



LINCE AVANT



FALC

Via Proventa, 41
48018 Faenza (Italia)
Tel. +39 0546 29050

www.falc.eu | info@falc.eu

